

L-SUBGIRT

PREFORMED CLADDING SUPPORT

TECHNICAL INFORMATION

HORIZONTAL L-SUBGIRT SYSTEM UTILIZING ISO CLIPS

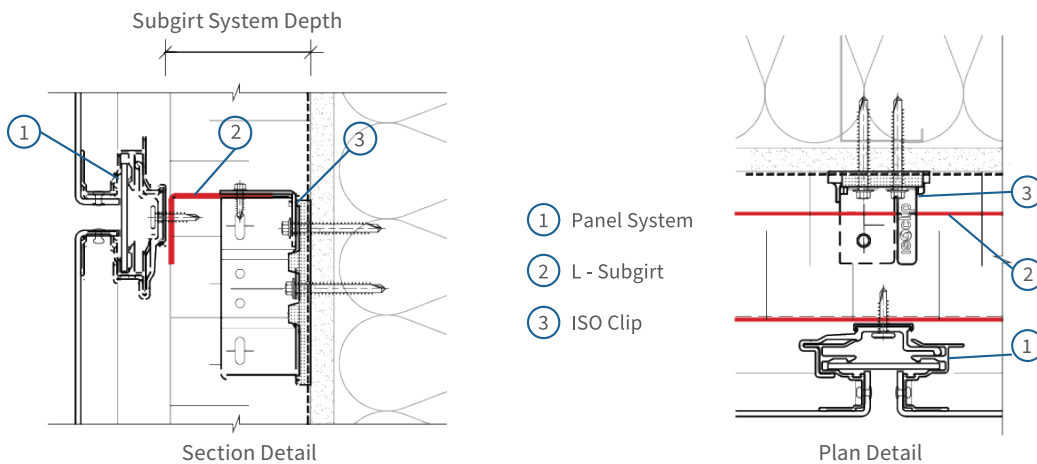

VERTICAL L-SUBGIRT SYSTEM UTILIZING ISO CLIPS

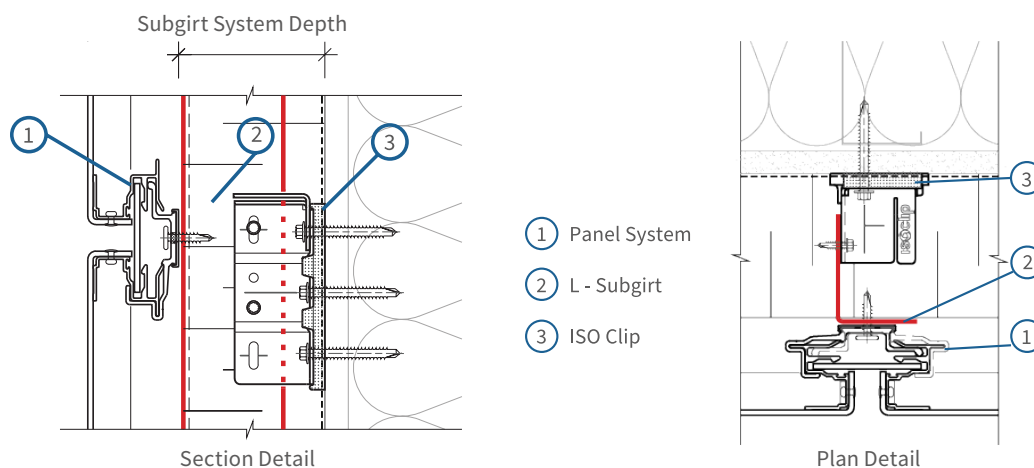

2.0" ISO CLIP COMPATIBLE L-SUBGIRT

HORIZONTAL ORIENTATION

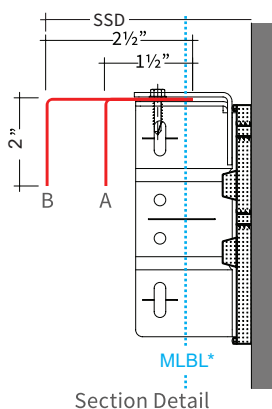

Insulation Depth	Subgirt Dimensions	Subgirt System Depth (SSD)	Profile
2" - 2 1/2"	1 1/2" x 2"	2" - 2 5/8"	A
3" - 3 1/2"	2 1/2" x 2"	3" - 3 5/8"	B

- Available in Galvanized G90 or Galvalume
- Gauges Available: 20, 18, 16, 14
- Min/Max Lengths Available: 4' - 20'
- MLBL* Subgirt must be installed past the Minimum Load Bearing Line

VERTICAL ORIENTATION

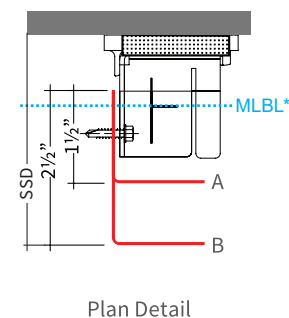

ISOclip
THERMAL ISOLATION CLIP

ISOCLIPS.COM
1-844-740-2050
info@isoclips.com

Fabricated by
Northern Facades Ltd.
Northernfacades.com

L-SUBGIRT

PREFORMED CLADDING SUPPORT

TECHNICAL INFORMATION

3.25" ISO CLIP COMPATIBLE L-SUBGIRT

HORIZONTAL ORIENTATION

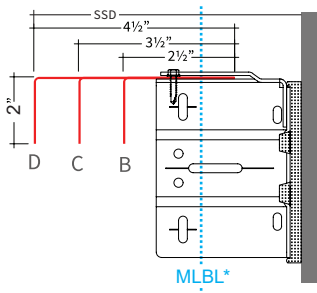

Section Detail

Insulation Depth	Subgirt Dimensions	Subgirt System Depth (SSD)	Profile
4"	2 1/2" x 2"	3 3/4" - 4 3/4"	B
5"	3 1/2" x 2"	4 3/4" - 5 3/4"	C
6"	4 1/2" x 2"	5 3/4" - 6 3/4"	D

- Available in Galvanized G90 or Galvalume
- Gauges Available: 20, 18, 16, 14
- Min/Max Lengths Available: 4' - 20'
- MLBL* Subgirt must be installed past the Minimum Load Bearing Line

VERTICAL ORIENTATION

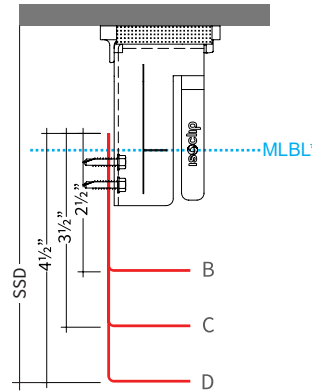

Plan Detail

4.75" ISO CLIP COMPATIBLE L-SUBGIRT

HORIZONTAL ORIENTATION

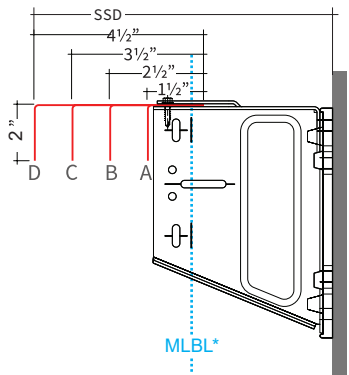

Section Detail

Insulation Depth	Subgirt Dimensions	Subgirt System Depth (SSD)	Profile
5"	1 1/2" x 2"	4 3/4" - 5 1/4"	A
6"	2 1/2" x 2"	5 1/4" - 6 1/4"	B
7"	3 1/2" x 2"	6 1/4" - 7 1/4"	C
8"	4 1/2" x 2"	7 1/4" - 8 1/4"	D

- Available in Galvanized G90 or Galvalume
- Gauges Available: 20, 18, 16, 14
- Min/Max Lengths Available: 4' - 20'
- MLBL* Subgirt must be installed past the Minimum Load Bearing Line

VERTICAL ORIENTATION

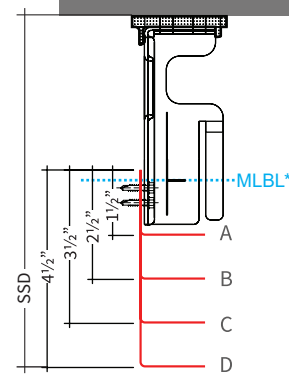

Plan Detail

7.75" ISO CLIP COMPATIBLE L-SUBGIRT

HORIZONTAL ORIENTATION

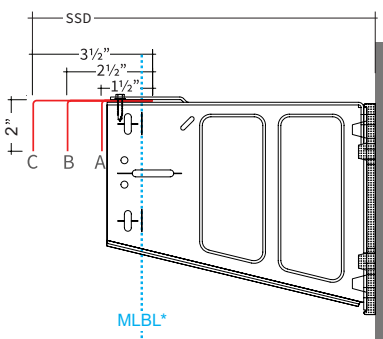

Section Detail

Insulation Depth	Subgirt Dimensions	Subgirt System Depth (SSD)	Profile
8"	1 1/2" x 2"	7 3/4" - 8 1/4"	A
9"	2 1/2" x 2"	8 1/4" - 9 1/4"	B
10"	3 1/2" x 2"	9 1/4" - 10 1/4"	C

- Available in Galvanized G90 or Galvalume
- Gauges Available: 20, 18, 16, 14
- Min/Max Lengths Available: 4' - 20'
- MLBL* Subgirt must be installed past the Minimum Load Bearing Line

VERTICAL ORIENTATION

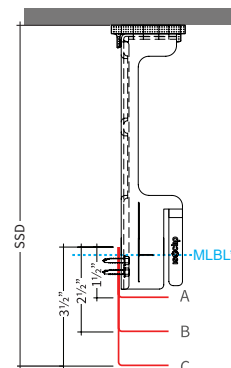

Plan Detail

ISOclip
THERMAL ISOLATION CLIP

ISOCLIPS.COM
1-844-740-2050
info@isoclips.com

Fabricated by
Northern Facades Ltd.
Northernfacades.com